



ATyS d 3200A

Remotely operated motorised switch (RTS)

WEIGHT:
545 kg

DIMENSIONS:
L: 1000 mm
W: 1000 mm
H: 1800 mm

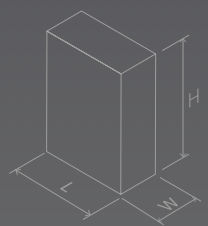





 CE certified

Image for orientation purposes. Dagartech reserves the right to modify the data in this technical sheet without prior notice.

 Supply voltage
208-277VAC±20%

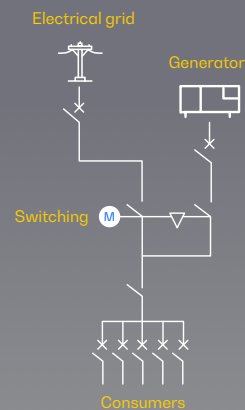
 Plug&play
Solution

 Emergency manual
start

 Watchdog
relay

 IEC 60947-6-1 AC
31B (up to 3200A)

1. General technical data

General technical data	Rated voltage	230VAC	
	Voltage supply range	177-288VAC	
	Frequency	50Hz / 60Hz	
	Number of poles	4	
	IP protection degree	43	
	Cutting and isolating devices	Mechanically interlocked	
	Cutting sectioning	Total Apparent	
	Operating mode	Automatic / manual operation mode with interlocking	
	Blocking	Lock - padlock	
	Cable connection	Low/low	
	Fastening system	Ground fixing	
Frame colour	RAL 7035		

- ATyS d devices are **4-pole remotely operated motorised transfer switches** with fully apparent cutoff.
- They allow the **on-load transfer of two three-phase power supplies via de-energised remote contacts**, from an external automatic controller, using pulse logic or a switch.
- They are **designed for use in low voltage systems** where an interruption of power to the load during transfer is acceptable.

Environmental conditions	Humidity (non-condensing)	55 °C	80%	
		40 °C	95%	
	Temperature	No de-rating	-20°C +40°C	
		With de-rating	-20°C < t ≤ +70°C	
	Altitude	No de-rating	Max 2000m	
			2000 m<A≤3000	3000m<A≤4000
	Correction factors	EU	0,95	0,8
IE		0,85	0,85	

Directives and Regulations

At a minimum, the ATyS d M models comply with the following international standards

- IEC 60947-6-1
- GB 14048-11
- EN 60947-6-1
- VDE 0660-107
- BS EN 60947-6-1
- NBN EN 60947-6-1
- IEC 60947-3
- IS 13947-3
- EN 60947-3
- NBN EN 60947-3
- BS EN 60947-3

2. Electrical specifications

Amperage		3200A
Frequencies		50Hz / 60Hz
Thermal intensity (Ith) at 40°C (A)		3200
Thermal intensity (Ith) at 50°C (A)		N/A
Thermal intensity (Ith) at 60°C (A)		N/A
Thermal intensity (Ith) at 70°C (A)		N/A
Rated insulation voltage Ui (V) (Power circuit)		1000
Rated impulse voltage Uimp (V) (Power circuit)		12
Rated insulation voltage Ui (V) (Control circuit)		300
Rated impulse voltage Uimp (V) (Control circuit)		4
Rated operating current, Ie (A) IEC 60947-3 at 415VAC - 40°C	AC 21A / 21B ¹	-/3200
	AC 22A / 22B ¹	N/A
	AC 23A / 23B ¹	N/A
Rated operating current, Ie (A) IEC 60947-6-1 at 415VAC - 40°C	AC 33A / 32B	N/A
Short-circuit fuse protection (use of DIN gG fuses)	Expected short-circuit current (kA eff)	N/A
	Associated fuse rating (DIN gG)	N/A
Short-circuit capability	Rated short-time withstand current 1s ICW (kA)	N/A
	Rated short-time withstand current 30 ms ICW (kA)	N/A
	Rated short-time withstand current 60 ms ICW (kA)	50
	Rated short-time withstand current 1ms ICW (kA)	50
Reaction time (excluding loss of supply detection time and excluding any applicable delay timer)	I-II or II-I/I-O OR O O-II (s)	2/1
	Duration of the "blackout" in Un(s)	1
Consumption	Network current (A)	N/A
	Steady state consumption (VA)	N/A
Mechanical characteristics	Number of manoeuvres	3000
Conductor cross-section (not compatible with aluminium cables)	Minimum cross-section (Cu mm ²), rigid and flexible	N/A
	Maximum cross-section (Cu mm ²), rigid and flexible	N/A
Minimum / maximum power supply (VAC)		166/332
Nominal power consumption electric control (start/nominal) (VA)		834/344

¹Category of use with **indication A**: Frequent manoeuvres / Category of use with **indication B**: non-frequent manoeuvres.

V.0 - 2024. Last update: 19/04/2024. Indicative technical plan and indicative images. Dagartech reserves the right to modify the data in this technical sheet without prior notice.

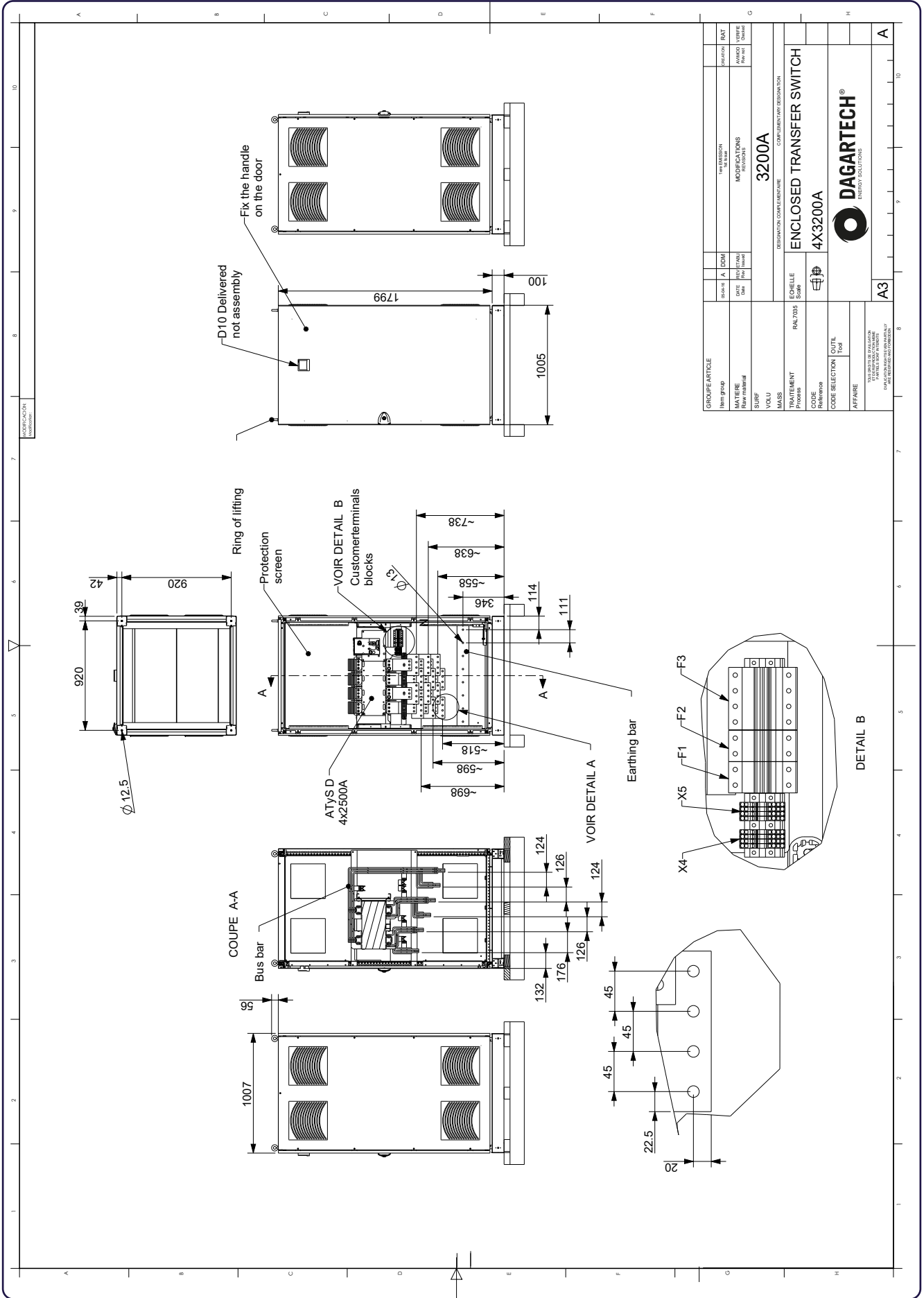

GROUP/ARTICLE	Item group	Item description	Quantity	Unit
MATIERES	Raw materials	MATERIALS	Quantity	Unit
VOIR	Raw materials	VOIR	Quantity	Unit
MASS	Raw materials	MASS	Quantity	Unit
TRATTAMENTO	Process	TRATTAMENTO	Quantity	Unit
CODE	Reference	CODE	Quantity	Unit
CODE SELECTION	Tool	CODE SELECTION	Quantity	Unit
AFFAIRE		AFFAIRE	Quantity	Unit

DESIGNATION COMPLÉMENTAIRE	COMPLÉMENTAIRE DESIGNATION
3200A	3200A
ENCLOSÉ TRANSFER SWITCH	ENCLOSÉ TRANSFER SWITCH
4X3200A	4X3200A

SCALE	SCALE
A3	A3

DAGARTECH®	
ENERGY SOLUTIONS	

Indicative technical plan and indicative images. Dagartech reserves the right to modify the data in this technical sheet without prior notice.

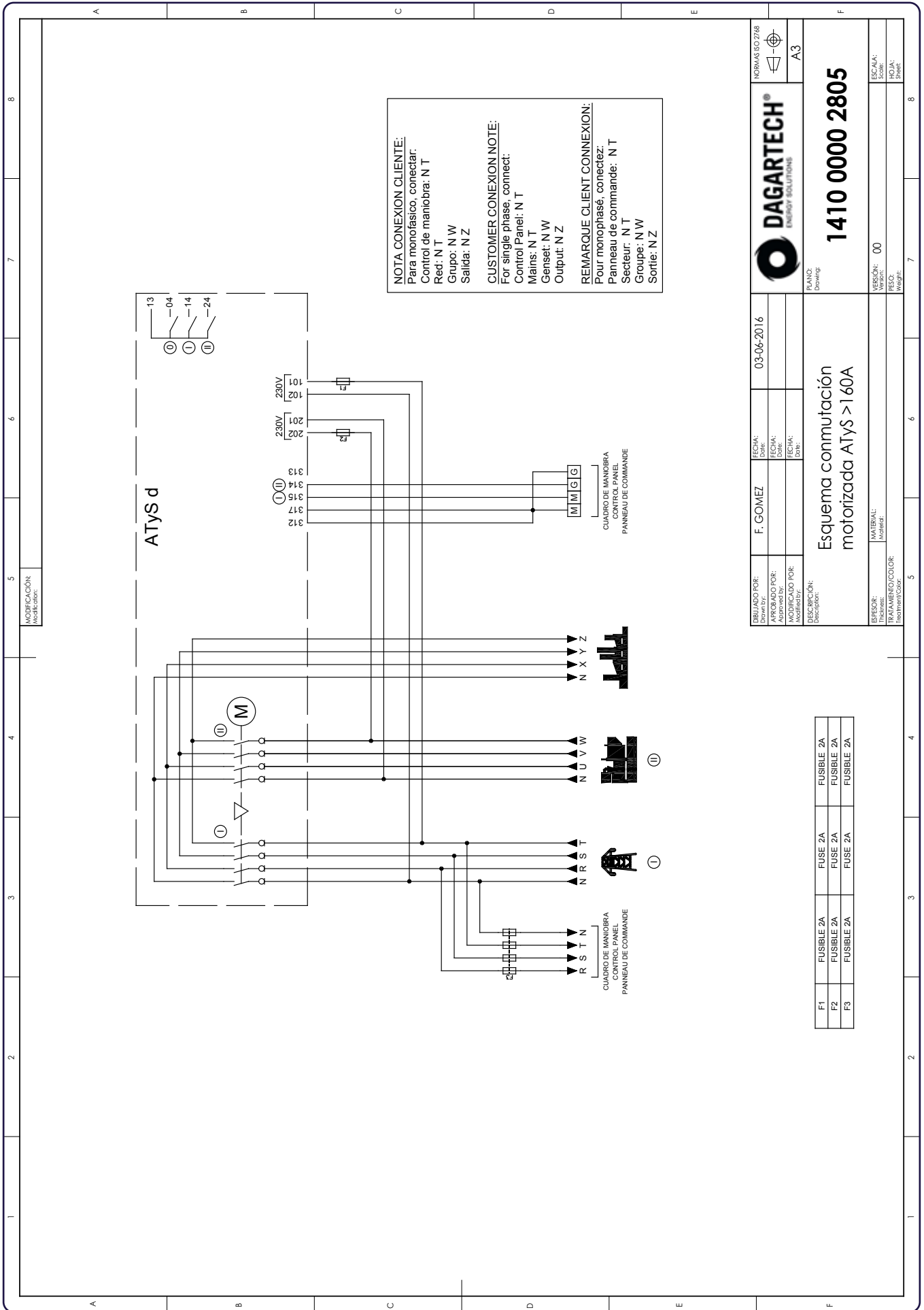

NOTA CONEXION CLIENTE:
 Para monofásico, conectar:
 Control de maniobra: N T
 Red: N T
 Grupo: N W
 Salida: N Z

CUSTOMER CONEXION NOTE:
 For single phase, connect:
 Control Panel: N T
 Mains: N T
 Genset: N W
 Output: N Z

REMARQUE CLIENT CONNEXION:
 Pour monophasé, connectez:
 Panneau de commande: N T
 Secteur: N T
 Groupe: N W
 Sortie: N Z

		NORMAS ISO 9001 	
DISEÑADO POR: APROBADO POR: MODIFICADO POR:	FECHA: FECHA: FECHA:	03-06-2016	
DESCRIPCIÓN: Descripción:			
Esquema conmutación motorizada ATys > 160A			
MATERIAL: Material:		00	
TRATAMIENTO/COLOR: Treatment/Color:		00	
VERSION: Escala:		00	
PESO: Weight:		00	

F1	FUSIBLE 2A	FUSE 2A	FUSIBLE 2A
F2	FUSIBLE 2A	FUSE 2A	FUSIBLE 2A
F3	FUSIBLE 2A	FUSE 2A	FUSIBLE 2A



DAGARTECH[®]

CUSTOM ENERGY SOLUTIONS

info@dagartech.com

T +34 976 141 655

**CUSTOM
ENERGY
SOLUTIONS**

dagartech.com